

Electronic Time Recorder

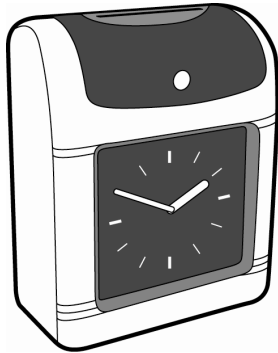

ANALOGUE



LCD

Instruction Manual

CONTENTS

1 Introduction	3
1.1 Package content	4
1.2 Parts identification.....	4
1.3 Setting select key.....	5
2 Function options.....	6
2.1 Quick codes' selection.....	6
2.2 Detail codes' selection.....	7
3 Be ready for setting.....	8
4 Function setting.....	8
4.1-4.5 Setting of year, month, date, hour, minute.....	9
4.6 Setting the regular time signal.....	10
4.7 Setting the date changing time.....	10
4.8 Setting the shifting time.....	11
4.9 Setting the 2 colors printing time.....	11
4.10 Setting the extension time signal.....	11
4.11 Adjusting printing position.....	12
4.12 Detecting front/back of time cards.....	12
4.13 Setting the Monthly, Weekly pay period ending day.....	12
4.14 Setting the S/W solstice start (month and day)	13
4.15 Setting the S/W solstice start (hour and minute)	13
4.16 Setting the S/W solstice end (month and day)	13
4.17 Setting the S/W solstice end (hour and minute)	14
5. All reset.....	14
6. Trouble shooting.....	14
7. Replacing ribbon cartridge.....	15
8. Cautions.....	15
9. Specifications.....	16
10. Error Code.....	16

1. Introduction

In order to operate your time recorder accurately and efficiently with a longer product life, please read this manual thoroughly.

Models Functions	LCD	Analogue
LCD Display	*	
Clock Face		*
Two color printing	*	*
Time Signal	*	*
Perpetual calendar	*	*
Back up battery	*	*
Auto In-Out adjustment	*	*
External Signal Unit	*	*
Data memory backup during power failure	*	*
Check time card's front or back automatically. If it inserts the wrong side, it will quit by the machine.	*	*

1.1 Package Contents

Unpack the time recorder and check its contents to ensure that the time recorder unit and all accessories as shown below are included.

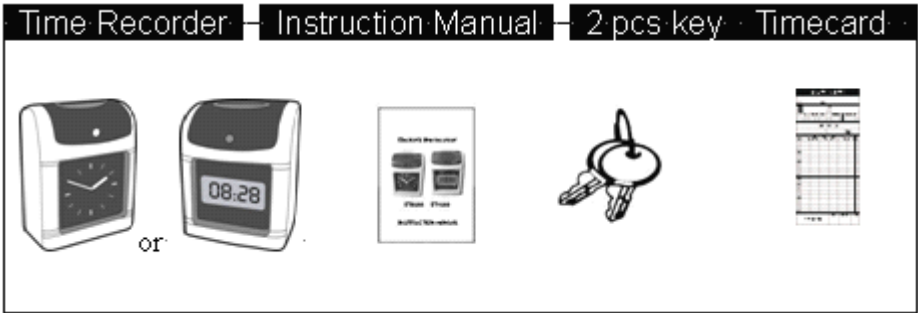

1.2 Parts Identification

(a) Keypad

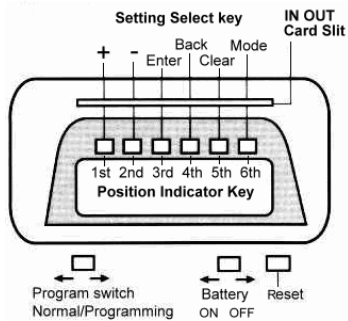

(b) LCD on the top

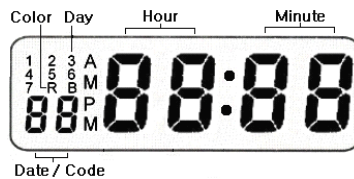

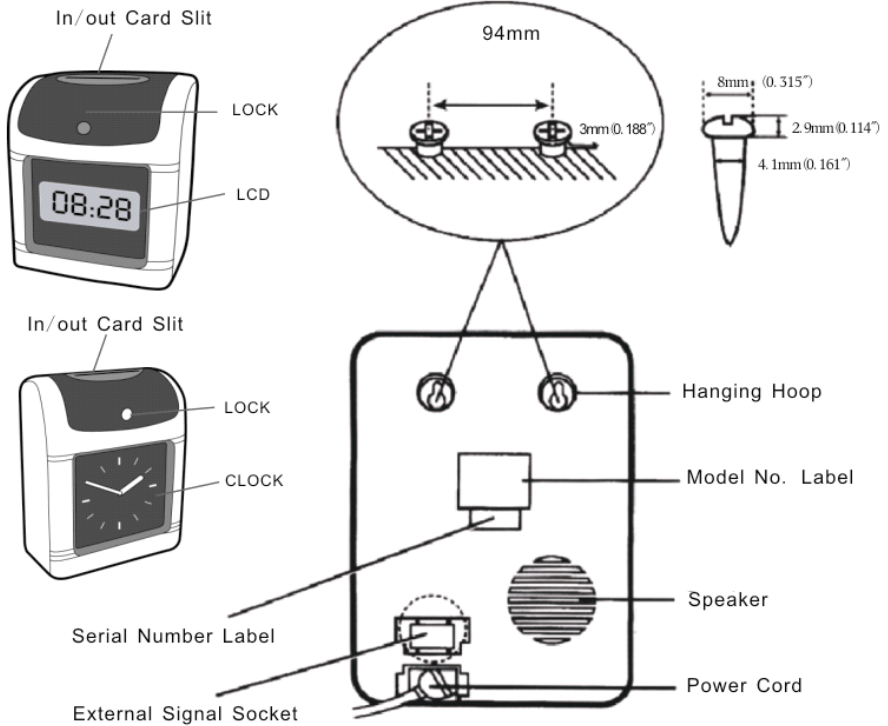

1.3 Setting select key

+	Increase the set value by 1
-	Decrease the set value by 1
Enter	Save the set value & enter the next step
Back	Backspace the set value
Clear	Cancel the set value
Program switch	Normal/ Programming
Battery	Battery On/Off
Reset	Reset

2. Function options

The function options will be started by unlocking and removing the lid from the time recorder with the program switch to right side. Here are total 37 function codes, which are from “00, 01, 02...” to “37”, different codes are for different settings. In the case, press “Enter” to select the codes forward or press “Back” to select backward for functions setting expected and press “+” to increase the value as well as press “-” to decrease the value.

2.1 Quick codes' selection:

00-04---Setting the time (Year, Month, Date, Hour, Minute)

05-11---Setting the regular time signal

12-----Setting the day changing time

13-18---Setting the shifting time

19-24---Setting the 2-color printing

25-30---Setting the extension time signal

31-----Printing position adjustment (up/down)

32-----Detecting front/back of card

33-----Setting the Monthly, Weekly pay period ending day

34-----Setting the S/W solstice start (month and day)

35-----Setting the S/W solstice start (hour and minute)

36-----Setting the S/W solstice end (month and day)

37-----Setting the S/W solstice end (hour and minute)

2.2 Detail codes' selection:

Code	Functions
00	Setting the Year
01	Setting the Month
02	Setting the Date
03	Setting the Hour
04	Setting the Minute
05	Setting the duration of time signal(Seconds)
06	Setting the time of 1 st group of ringing
07	Setting the time of 2 nd group of ringing
08	Setting the time of 3 rd group of ringing
09	Setting the time of 4 th group of ringing
10	Setting the time of 5 th group of ringing
11	Setting the time of 6 th group of ringing
12	Setting the date changing time
13	Setting the time of shifting to 1 st column
14	Setting the time of shifting to 2 nd column
15	Setting the time of shifting to 3 rd column
16	Setting the time of shifting to 4 th column
17	Setting the time of shifting to 5 th column
18	Setting the time of shifting to 6 th column
19	Setting the time of 1 st group of changing color(Red)
20	Setting the time of 2 nd group of changing color(Black)
21	Setting the time of 3 rd group of changing color(Red)
22	Setting the time of 4 th group of changing color(Black)
23	Setting the time of 5 th group of changing color(Red)
24	Setting the time of 6 th group of changing color(Black)
25	Setting the time of 7 th group of ringing
26	Setting the time of 8 th group of ringing
27	Setting the time of 9 th group of ringing
28	Setting the time of 10 th group of ringing
29	Setting the time of 11 th group of ringing

30	Setting the time of 12 th group of ringing
31	Adjusting Printing position (up/down)
32	Detecting front/back of card
33	Setting the Monthly, Weekly pay period ending day
34	Setting the S/W solstice start (month and day)
35	Setting the S/W solstice start (hour and minute)
36	Setting the S/W solstice end (month and day)
37	Setting the S/W solstice end (hour and minute)

3. Be ready for setting

1. Power Supply

- (1) Stable power source is highly recommended.
- (2) Please check the correct voltage & power cord before use.

2. Top Cover

Remove the top cover prior to set program or change the ribbon case
 Open the top cover by using the key provided and remove the top cover.

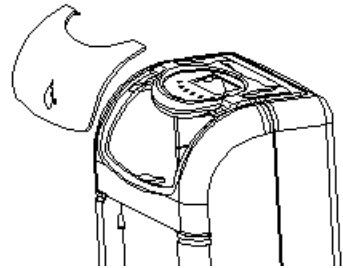

4. Function Setting

After removing the lid from the time recorder, turn the program switch to right side to enter setting condition. Press “Enter” to select the codes forward or press “Back” to select backward for functions setting expected and, press “+” to increase the value or press “-” to decrease the value and, press “Enter” to save the set value and start the next setting.

4.1 Setting the Year

Turn the program switch to right side, the Codes will begin from "00"

(00 display on the left corner indicates the program Code),

The digital display reads 2010 indicates year 2010, The year

"06" flashes on the right of the digital display, press the **+** or **-** button to set the year. Press **Enter** to register the setting.

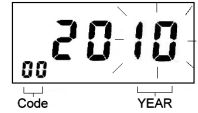

4.2 Setting the Month

Press **Enter** or **Back** to enter the program Code **01**,

press **+** or **-** button to set the month. Press **Enter** again to register the setting value.



4.3 Setting the date

Press **Enter** or **Back** to enter the program Code **02**,

press **+** or **-** button to set the day. Press **Enter** again to register the setting value.



4.4 Setting the Hour

Press **Enter** or **Back** to enter the program Code **03**,

Press **+** or **-** button to set the Hour. Press **Enter** again to register the setting value.



4.5 Setting the Minute

Press **Enter** or **Back** to enter the program Code **04**,

press **+** or **-** button to set the Minute. Press **Enter** again to register the setting value.



4.6 Setting the regular time signal (0-99Seconds)

Press **Enter** or **Back** to enter the program Code **05**,

Press **+** or **-** button to set time signal duration and the initial value (10 seconds) will appear.

The duration can be set from 0~99 seconds,

Press **Enter** again to register the setting value and enter code **06** so as to setting the time of 1st ringing

Press **+** or **-** button to set the Hour.

Press **Enter** again to register the setting value.

Press **+** or **-** button to set the Minute.

Press **Enter** again to register the setting value.

Doing the same as above to enter code 07, 08, 09, 10, 11 and complete the setting of 2nd, 3rd, 4th, 5th, 6th ring times.



4.7 Setting the Date Change time

Press **Enter** or **Back** to enter the program Code **12**,

press **+** or **-** button to set the Hour. Press **Enter** again to register the setting value.

press **+** or **-** button to set the Minute. Press **Enter** again to register the setting value.

Note: The default is 00:00, the day and printing line will change to the next at the time.

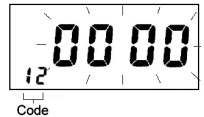

4.8 Setting the shifting time

Press **Enter** or **Back** to enter the program Code **13**,

Press **+** or **▢** button to set the Hour.

Press **Enter** again to register the setting value.

Press **+** or **▢** button to set the Minute.

Press **Enter** again to register the setting value.

Doing the same as above to enter code 14, 15, 16, 17, 18 and complete the setting of 2nd, 3rd, 4th, 5th, 6th shifting times.

The format below is for reference:

Print Column	1	2	3	4	5	6
Function	A.M. IN	A.M. OUT	P.M. IN	P.M. OUT	O.T. IN	O.T. OUT



4.9 Setting the 2-color printing

Press **Enter** or **Back** to enter the program Code **19**,

Press **+** or **▢** button to set the Hour.

Press **Enter** again to register the setting value.

Press **+** or **▢** button to set the Minute.

Press **Enter** again to register the setting value.

Doing the same as above to enter code 20, 21, 22, 23, 24 and complete the setting of 2nd, 3rd, 4th, 5th, 6th change color times if necessary.



4.10 Setting the extension time signal

Press **Enter** or **Back** to enter the program Code **25**,

Press **+** or **▢** button to set the Hour.

Press **Enter** again to register the setting value.

Press **+** or **▢** button to set the Minute.

Press **Enter** again to register the setting value, the 7th extension ringing time is set.

Doing the same as above to enter code 26, 27, 28, 29, 30 and complete the setting of 8th, 9th, 10th, 11th, 12th extension ringing times.

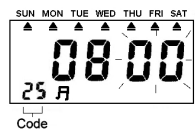
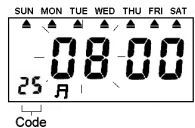

4.11 Adjusting printing position (Up/Down)

Press **Enter** or **Back** to enter the program code **31**,
Press **+** or **-** button to set the printing position <0~5>
Press **Enter** again to register the setting value.
Higher value, printing moves upward, lower value,
printing moves downward.

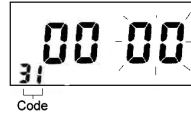

4.12 Detecting front/back of cards

Press **Enter** or **Back** to enter the program code **32**.
Press **+** or **-** button to select the flashing value “0000” or “0001”,
“0000” is for closing this function, “0001” is for starting this function.
Press **Enter** again to register the setting value.

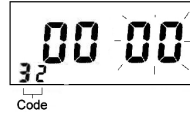

***The detection function operates only when you use specific time cards (monthly pay cards) with front/back detection cut-out.**

4.13 Setting the Monthly, Weekly pay period ending day

Press **Enter** or **Back** to enter the program code **33**.
Press **+** or **-** button to set the card type
Press **Enter** again to register the setting value



Card Type	Functions
00	Month pay time card
01	Weekly pay time card

4.13a Setting the Monthly pay period end day

When the card type is set to 00, the first row on the 1~15 row card surface is automatically as blank row. The set value is from 00 to 31

4.13b Setting the Weekly pay period end day

Press **Enter** or **Back** to enter the program code 33

Press **+** or **-** button to set the card type to 01

Press **Enter** again to register the setting value

Press **+** or **-** button to set the Weekly pay period end day,

The set value is from 0 to 6, which means Sunday to Saturday.

Press **Enter** again to register the setting value.



4.14 Setting the S/W solstice start (month and day)

Press **Enter** or **Back** to enter the program code 34,

press **+** or **-** button to set the start month.

Press **Enter** again to register the setting value.

press **+** or **-** button to set the start date.

Press **Enter** again to register the setting value.



4.15 Setting the S/W solstice start (hour and minute)

Press **Enter** or **Back** to enter the program code 35,

press **+** or **-** button to set the start hour.

Press **Enter** again to register the setting value.

press **+** or **-** button to set the start minute.

Press **Enter** again to register the setting value.



4.16 Setting the S/W solstice end (month and day)

Press **Enter** or **Back** to enter the program code 36,

press **+** or **-** button to set the end month.

Press **Enter** again to register the setting value.

press **+** or **-** button to set the end date.

Press **Enter** again to register the setting value.



4.17 Setting the S/W solstice end (hour and minute)

Press **Enter** or **Back** to enter the program code **37**,

press **+** or **□** button to set the end hour.

Press **Enter** again to register the setting value.

press **+** or **□** button to set the end minute.

Press **Enter** again to register the setting value.



5. All Reset

Press “Reset” key to re-start the whole machine.

Press **+** & **Clear** & **Mode** (Key **1, 5, 6**) all together to restore the default value, including Date, Time, Time Signal, Color Change, Printing Position.

6. Trouble Shooting

© Press **RESET** button to re-start the program when it is not properly work.

Trouble	Causes	Corrective Measures
The time recorder does not accept time card	<ol style="list-style-type: none"> 1. Power failure 2. The time card is damaged 3. The power cord is disconnected. 4. Cards were inserted or pulled out by force. 	<ol style="list-style-type: none"> 1. Wait until power supply is restored 2. Change a new time card 3. Insert the power plug firmly into the power outlet. 4. Pull the power plug out of the power outlet, then insert again.
The clock is slow (or fast)	<ol style="list-style-type: none"> 1. Mistakes in setting the clock. 2. Power failure 	Set it correctly.
Light printing	<ol style="list-style-type: none"> 1. The ribbon cartridge is not set correctly. 2. The cartridge has been used for long time. 	<ol style="list-style-type: none"> 1. Set it correctly. 2. Change a new cartridge.
The printing position is wrong	<ol style="list-style-type: none"> 1. Incorrect setting of day change. 2. Improper use of the time recorder. 	<ol style="list-style-type: none"> 1. Set it correctly. 2. Make sure to insert the card in the card slot and remove it properly.
The date is incorrect	Mistakes in setting the date	Set it correctly.
Imperfect printing	Improper use of the time recorder	Make sure to insert card in the middle of card slot and remove then properly.

7. Replacing Ribbon Cartridge

1. Open the top cover, press Column 4 to move the ribbon cartridge to center.
2. As shown in the figure below, pull the ribbon holders towards you and, holding them steady in the position, use the handle to take out the cartridge.

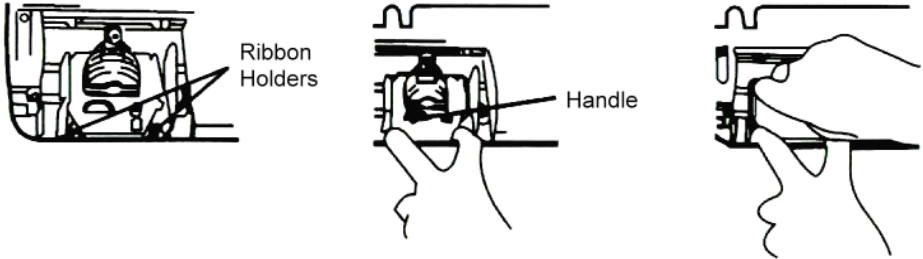

3. Correctly insert a new cartridge between the ribbon guide and the printer head.
Push the cartridge head until it clicks into place. Turn the knob clockwise to fasten the ribbon.

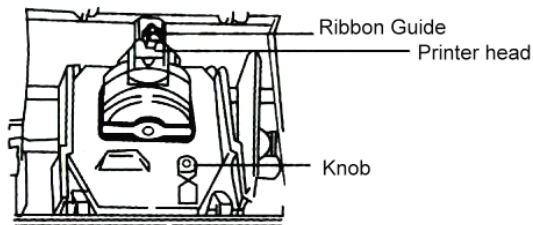

8. Cautions

1. To avoid fire or electric shock, please do not expose this machine to rain or excessive condensed moisture.
2. Do not expose to direct sunlight, strong heat source or dusty area.

9. Specifications

Power Supply	DC13V 1.5A Input (Refer to the indication on the label of each machine)
Power Consumption	Standby:2W / Work:10W
Dimensions	Approx. 193 x 244 x 123 mm (L x W x H)
Weight	2.4 KGS
Usage Environment	-30°C~40°C
	10%RH~80%RH
Time Card Sizes	85 x 188 x 0.35 mm (W x L x H)
Ribbon Cartridge	RN-16(D)

10. Error Code

Once the E1E1, E2E2, shown on LCD display, please contact your dealer from whom you purchased the time recorder.

E1E1--Wrong position of Up & Down

E2E2--Wrong position of left & right

It is recommended to use genuine manufacturer time recorder ribbons. Usage of non genuine or compatible ribbons may damage your printer and void your warranty.